

JUPITER

...Your Lighting Destiny



PRODUCT CATALOGUE

2023 - 2024

JUPITER

...Your Lighting Destiny

In an era defined by remarkable technological advancement, the realm of LED lighting has emerged as a beacon of innovation, bringing forth a multitude of benefits such as energy efficiency, enhanced visual clarity, and unparalleled flexibility and controllability. It is with great enthusiasm that we introduce the Jupiter Lighting brand, a visionary endeavor by Rewire International LLC. This brand embodies a relentless pursuit of excellence, a commitment to value-driven solutions, and a profound dedication to addressing the dynamic demands of a competitive landscape of Architectural Lighting globally.

At Jupiter Lighting, we have harnessed the power of LED lighting technology to create a comprehensive suite of products that redefine illumination paradigms. With a team of accomplished experts boasting a wealth of global experience, and backed by state-of-the-art manufacturing facilities spanning Turkey and other continents, we stand poised to deliver cutting-edge LED lighting solutions for both indoor and outdoor environments. Our offerings span across a diverse array of applications including the architectural, hospitality, industrial, infrastructure, and healthcare sectors.

Our fundamental ethos revolves around providing cost-effective solutions with utmost quality & performance. Jupiter Lighting is not just a brand, but a symbol of unwavering commitment to delivering exceptional value. By aligning our expertise with the ever-evolving needs of the market, we have meticulously curated an array of architectural LED lighting solutions that stand as a testament to our dedication.

Further, our commitment to customization knows no bounds. With an expansive range of choices within each product category, we possess the capacity to tailor our offerings to meet the unique requirements of our valuable clientele. Be it a bespoke lighting solution for a sophisticated architectural marvel or a critical illumination system for a bustling industrial facility, Jupiter Lighting is primed to deliver with precision.

As you navigate the pages of this catalogue, you'll find a fusion of technology, design, and ingenuity, meticulously crafted to illuminate spaces in ways that captivate the imagination.

We extend our gratitude to those who have accompanied us on this journey—our patrons, partners, and collaborators. Your trust fuels our relentless pursuit of excellence, and we remain steadfast in our commitment to exceeding your expectations.

With utmost anticipation, we invite you to explore the world of Jupiter Lighting— a world where innovation and illumination converge to lead you to Your Lighting Destiny ...!!

CONTENT



Himalia
p. 009



Metis
p. 021



Isonoe
p. 033



Fosteri
p. 039



Thebe
p. 041



Kalyke
p. 043



Engix
p. 047



**Light Trim
for Engix**
p. 054



Fitix
p. 057



**Light Trim
for Fitix**
p. 061



XoFlex
p. 065



Sketch
p. 086



Flexion
p. 091



Linix
p. 097



Medalion
p. 111



Flattex
p. 119



Fort G
p. 123



Magtrax Spot L
p. 127



Magtrax Spot R
p. 134



Ceilmoon
p. 137



Bulko
p. 143



Atmosproof
p. 147

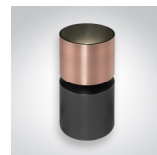

Plafond
p. 153



Ceilume R65
p. 155



Ceilume R40
p. 158



Palisade R
p. 167



Navix
p. 173



Spiky R
p. 179

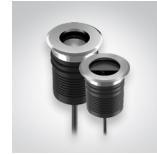

Ingrex R
p. 189



Ingrex L
p. 195



Hydra
p. 199



Stave
p. 203



Direkler
p. 204



Postix
p. 205



Zenith
p. 209



Altus
p. 211



Cresta
p. 213



Summitra
p. 215



Zenitron
p. 217



Apogeix
p. 219



Zenara
p. 221



Altara
p. 223



Lumiline 25
p. 227

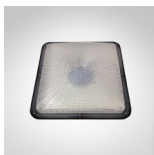

Velum
p. 233



Flare
p. 237



Amphi
p. 241











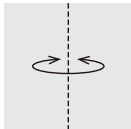
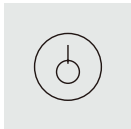

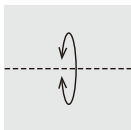
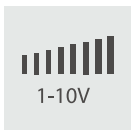
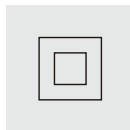
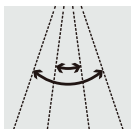



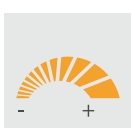
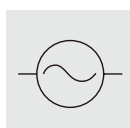

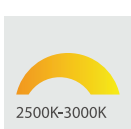
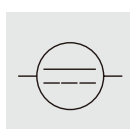
Roofbay Pro
p. 245

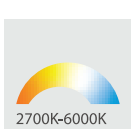
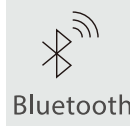
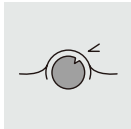

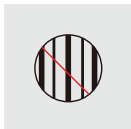
Wallux
p. 249

SELECTION RANGE

	Luminaire rotation about the vertical axis		ON/OFF		Class I products
	Luminaire angle relative to the horizontal plane		1-10 Volt		Class II products
	Adjustable beam angle		DALI dimming		Class III products
	Interchangeable reflector		Phase Dimming		AC appliances
	Degree of protection		Dim to warm 2500K-3000K		DC appliances
	Magnetic suction function		Tunable White 2700K-6000K		
					Smart Light Bluetooth
	Anti-dazzle		COB Chip on board		Smart Light Wireless
	Flicker-free products		SMD Surface mount led		Human body infrared sensing or light sensing Induction
					DMX 512 Color Mixing

COLOR TEMPERATURE

Warm White



Neutral White



Cool White



OTHER COLORS

Red



Green



Blue



Amber



WE USE



FULL COLOR



RGB



RxGxB



RGB 3in1

RGB



RGBW 4in1

RGBW

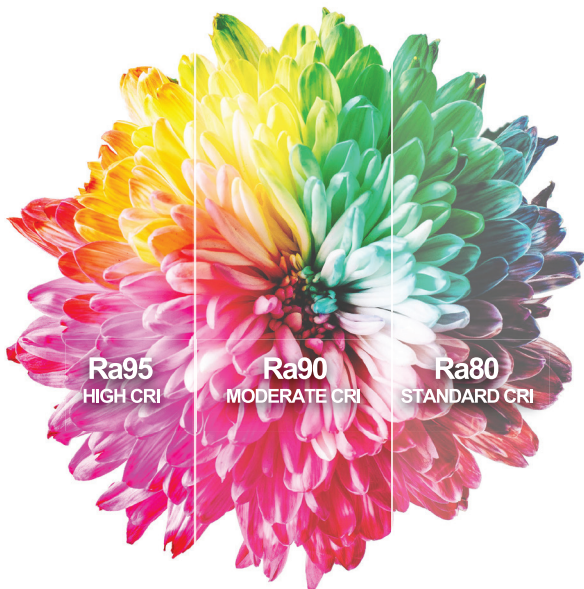

Ra95
HIGH CRI

Ra90
MODERATE CRI

Ra80
STANDARD CRI

CRI Options

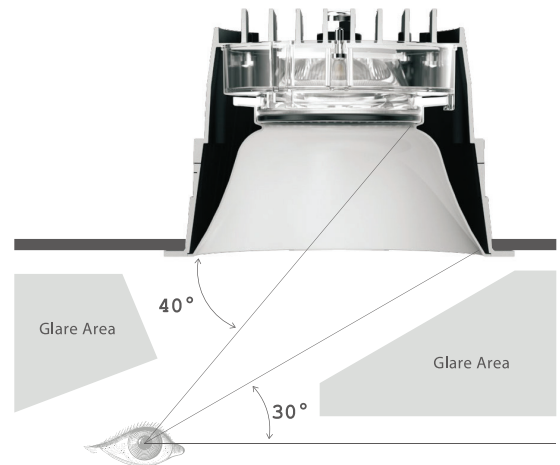

Low Glare Design

Disclaimer:

All trademarks, logos and brand names are the property of their respective owners. All company, product and service names used in this catalogue are for identification purpose only. Use of these names, trademarks and brands does not imply endorsement.

All projects/products application pictures used are for illustration purposes only.